

**BETTER LIGHTING LESS DISTRACTONS.
GREATER PRODUCTIVITY.**

ACOUSTIC LIGHTING

- High Sound Absorption Performance in NRC = 0.7 panels
- Excellent illumination performance
- Up to CRI>95 & R9>90
- 100% recyclable and odorless material
- Class A Fire retardant
- Various customized design in 4x8ft/ 1.22x2.44m acoustic panels

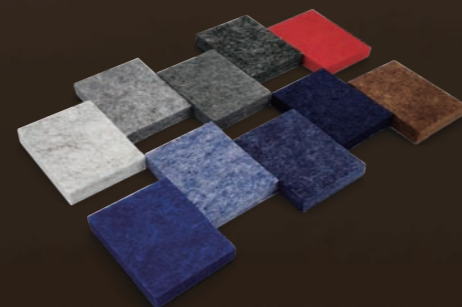

ORDERING INFORMATION

LUMINAIRE	ACOUSTIC COLOR	LENS	LENGTH	COLOR QUALITY ¹	COLOR TEMP ²	CRI	INSTALL ACCS.	IP GRADE	CONTROL OPTOINS
ACT-S	S- Silver Grey	D Diffuser	2- 628mm	3 3-Step MacAdam Ellipse	27- 2700K 30- 3000K 35- 3500K	90 90+ CRI	P Aircraft cable pendant	22 IP22	D1- DALI D2- 0-10V D3- On/off
	C- Concrete Grey								
	M- Moon Grey								
	CB- Cloudy Black		4- 1228mm	5 5-Step MacAdam Ellips	40- 4000K 50- 5000K	95 95+ CRI			
	CR- China Red								
	N- Navy Blue		5- 1528mm		60- 6000K 65- 6500K				
	SB- Stone Blue								
	O- Ocean Blue								
	I- Indigo Blue								
	CW- Camel Brown								

1. Vivalyte's standard is 3-Step MacAdam
 2. The listed Color Temperature is only available in CRI80+ in Epistar Chips, for 95+, 90+ in Epistar and Sumsung chips, pls. check the list on following page. For more options, pls. check with your executive sales.

COLOR OPTIONS

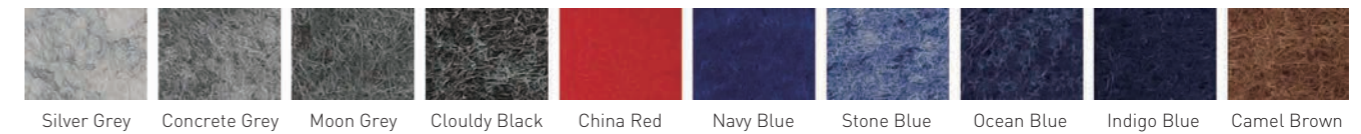

DIMENSIONS

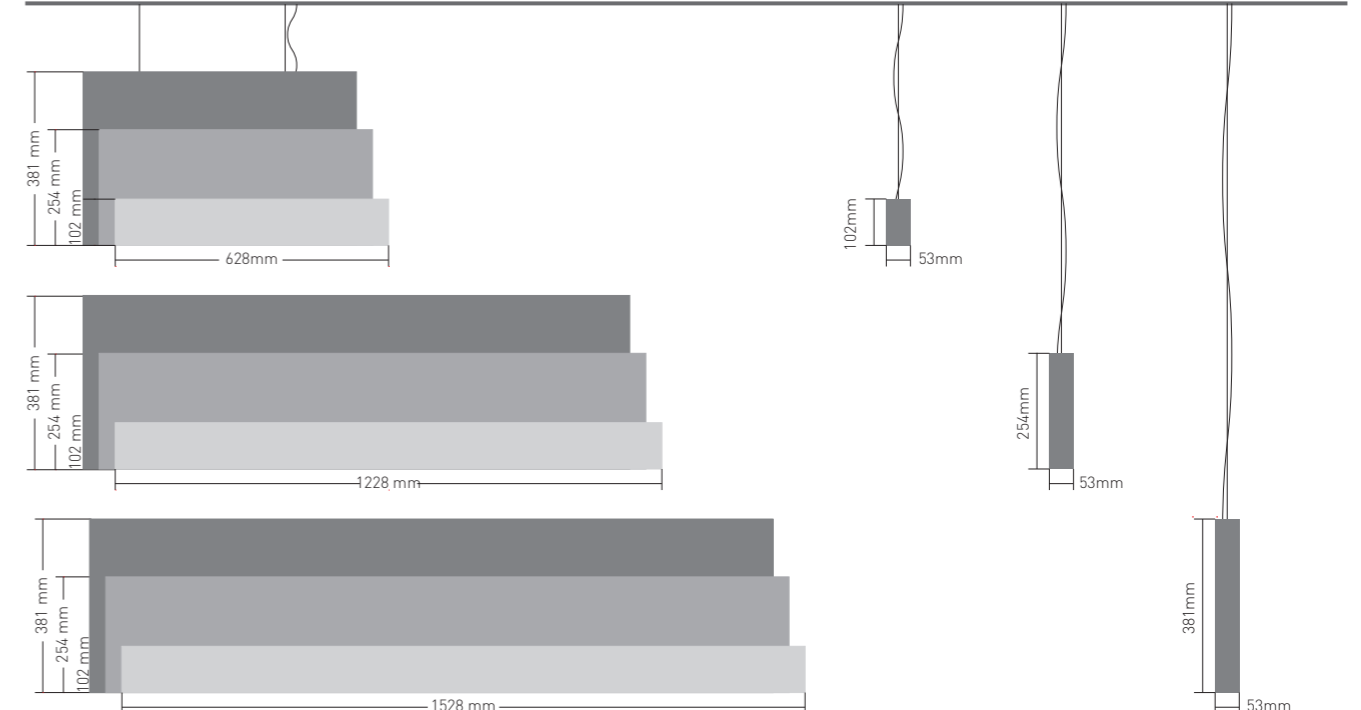

SPECIFICATIONS

Voltage	220V-240 VAC / 110-240VAC		
Width / Height	53mm x 102mm	53mm x 254mm	53mm x 381mm
Length	628mm	1228mm	1528mm
Power	11.5 W/pc	23 W/pc	27 W/pc
Efficacy Up to	85lm/w	90lm/w	90lm/w
Control	DALI , 0-10V, on/off		

LED CHIPS AND DRIVER OPTIONS



SPECIFICATIONS

	Color Temperature	Lumen / Length		
RA 90	2700K	710lm / 0.6m	1420lm / 1.2m	1667lm / 1.5m
	3000K	747lm / 0.6m	1495lm / 1.2m	1754lm / 1.5m
	3500K	787lm / 0.6m	1573lm / 1.2m	1847lm / 1.5m
	4000K	828lm / 0.6m	1656lm / 1.2m	1944lm / 1.5m
	5000K	828lm / 0.6m	1656lm / 1.2m	1944lm / 1.5m
	5500K	828lm / 0.6m	1656lm / 1.2m	1944lm / 1.5m
	6500K	828lm / 0.6m	1656lm / 1.2m	1944lm / 1.5m
RA 95	2700K	639lm / 0.6m	1277lm / 1.2m	1500lm / 1.5m
	3000K	673lm / 0.6m	1345lm / 1.2m	1579lm / 1.5m
	3500K	708lm / 0.6m	1416lm / 1.2m	1662lm / 1.5m
	4000K	745lm / 0.6m	1490lm / 1.2m	1749lm / 1.5m
	6500K	745lm / 0.6m	1490lm / 1.2m	1749lm / 1.5m
SAMSUNG RA 80	3000K	841lm / 0.6m	1681lm / 1.2m	1974lm / 1.5m
	4000K	932lm / 0.6m	1863lm / 1.2m	2187lm / 1.5m
	6500K	932lm / 0.6m	1863lm / 1.2m	2187lm / 1.5m

Note:

- The given data are typical values in PC Diffuser. Due to tolerances of the production process and the electrical components, values for light output and electrical power can vary up to 10%.
- 15% less on luminous flux at Traic driver, DALI and 0/1-10V driver, and -10% Non-Dim driver.
- Above data based on Non-Dimmable for all luminaires.
- More customized LED and CCT available.
- LM-80, IES TM-30-15 testing report available for led.



UGR < 16

ORDERING INFORMATION

LUMINAIRE	ACOUSTIC COLOR	LENS	LENGTH	COLOR QUALITY ¹	COLOR TEMP ²	CRI	INSTALL ACCS.	IP GRADE	CONTROL OPTOINS
ACT- SL	S- Silver Grey	T50R -Round in Square 50° TIR Lens in Square Louver	4- 1228mm Fixed length only	3 3-Step MacAdam Ellipse	30- 3000K 40- 4000K 50- 5000K 65- 6500K	80 80+ CRI 90 90+CRI	P Aircraft cable pendant	22 IP22	D1- DALI D2- 0-10V D3- On/off
	C- Concrete Grey								
	M- Moon Grey								
	CB- Cloudy Black	T50D -Round in Diamond 50° TIR Lens in Diamond Louver							
	CR- China Red								
	N- Navy Blue								
	SB- Stone Blue	T3575 -35° x 75° TIR Lens in Rectangle Louver							
	O- Ocean Blue								
	I- Indigo Blue								
	CW- Camel Brown	T5050 -50° x 50° TIR Lens in Square Louver							

1. Vivalyte's standard is 3-Step MacAdam

2. The listed Color Temperature is only available in CRI80+ in Nichia Chips. For more options, pls. check with your executive sales.

3: Nichia's CRI 90+ option's is not the general inventory, the leading time is around 4weeks for it. Please check with your executive sales in details.

SPECIFICATIONS

Voltage	220V-240VAC / 100V-240 VAC				
Width / Height	53mm x 102mm	53mm x 254mm	53mm x 381mm		
Length	Fixed in 1228mm				
Power (W/m /ft)	21 W/pc				
Efficacy Up to	90lm/W (RA 80+)	80lm/W (RA 90+)			
Control	Dali , 0-10V, on/off				
NICHIA RA 90	Color Temperature	3000K	4000K	5000K	6500K
	Lumen / Length	1516lm / 1.2m	1680lm / 1.2m	1680lm / 1.2m	1680lm / 1.2m

Note:

- The given data are typical values in PC Diffuser. Due to tolerances of the production process and the electrical components, values for light output and electrical power can vary up to 10%.
- 15% less on luminous flux at Traic driver,DALI and 0/1-10V driver, and -10% Non-Dim driver.
- Above data based on Non-Dimmable for all luminaires.
- More customized LED and CCT available.
- LM-80, IES TM-30-15 testing report available for led.

COLOR OPTIONS

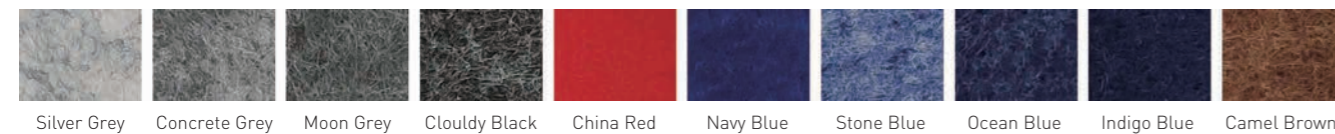

DIMENSIONS

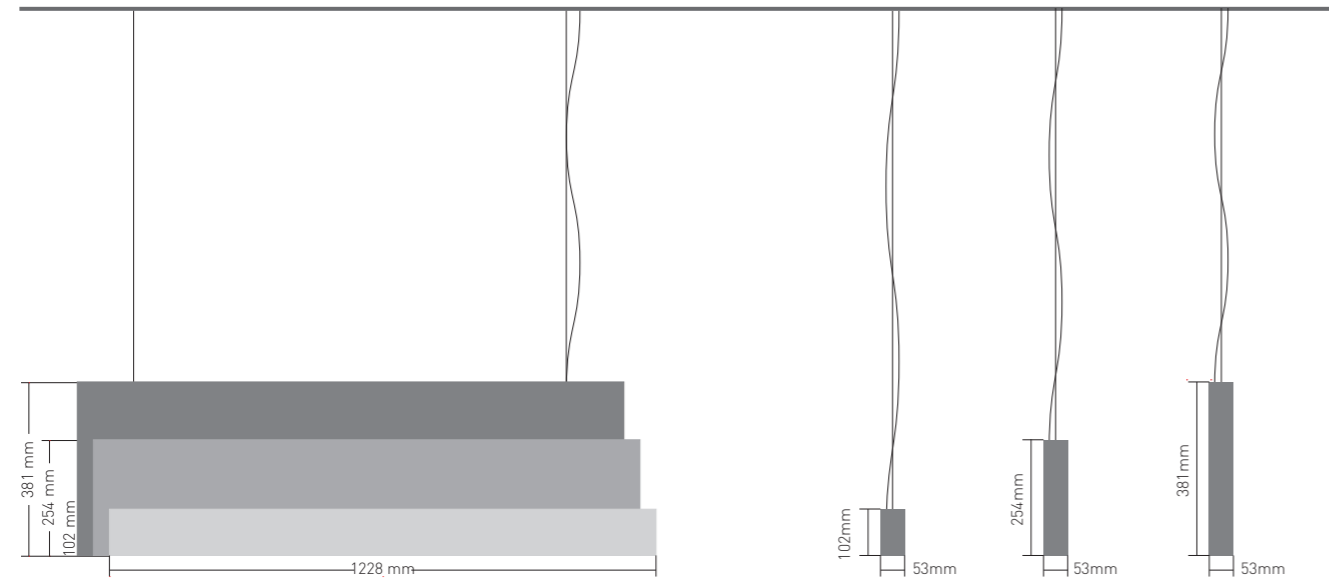

BEAM ANGLE

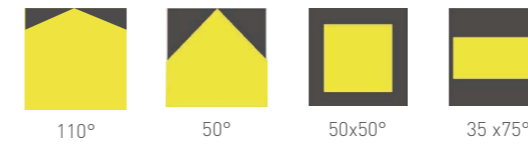

LED CHIPS AND DRIVER OPTIONS



DIMENSIONS OF OPTICE

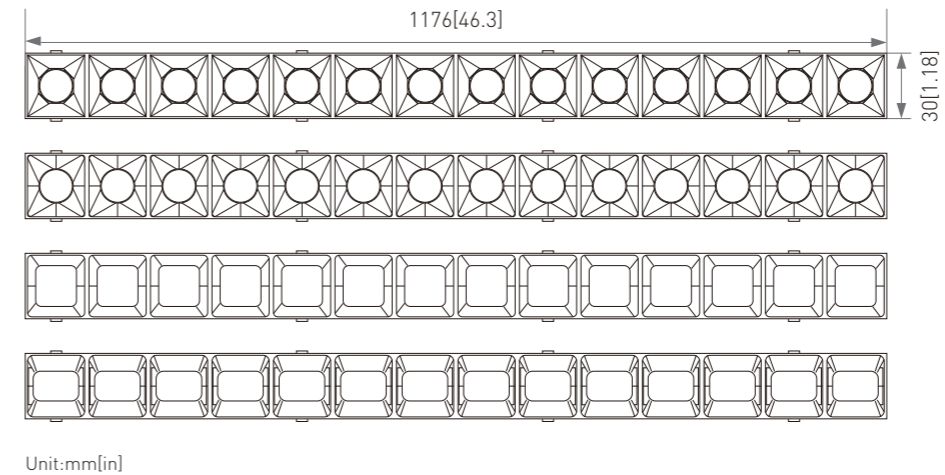



UGR
<19

ORDERING INFORMATION

LUMINAIRE	ACOUSTIC COLOR	LENS	LENGTH	COLOR QUALITY ¹	COLOR TEMP ²	CRI	INSTALL ACCS.	IP GRADE	CONTROL OPTOINS
ACT-L	S- Silver Grey	U- UGR<19 Kit	2- 628mm	3	27- 2700K	90	P Aircraft cable pendant	22 IP22	D1- DALI
	C- Concrete Grey		4- 1228mm	3-Step MacAdam Ellipse	30- 3000K	90+ CRI			
	M- Moon Grey	D- Diffuser	5- 1528mm	5	35- 3500K	95			
	CB- Cloudy Black		5-Step MacAdam Ellips	60- 6000K	95+ CRI				
	CR- China Red			65- 6500K					
	N- Navy Blue								
	SB- Stone Blue								
	O- Ocean Blue								
	I- Indigo Blue								
	CW- Camel Brown								

1. Vivalyte's standard is 3-Step MacAdam
 2. The listed Color Temperature is only available in CR180+ in Epistar Chips, for 95+, 90+ in Epistar and Sumsung chips, pls. check the list on following page. For more options, pls. check with your executive sales.

SPECIFICATIONS

Voltage	220V-240VAC / 100V-240 VAC		
Width / Height	68mm x 102mm	68mm x 254mm	68mm x 381mm
Length	628mm	1228mm	1528mm
Power (W/m /ft)	15.6 W/pc	31.1 W/pc	37.8 W/pc
Efficacy Up to	85lm/w	90lm/w	90lm/w
Control	Dali , 0-10V, on/off		

LED CHIPS AND DRIVER OPTIONS



COLOR OPTIONS

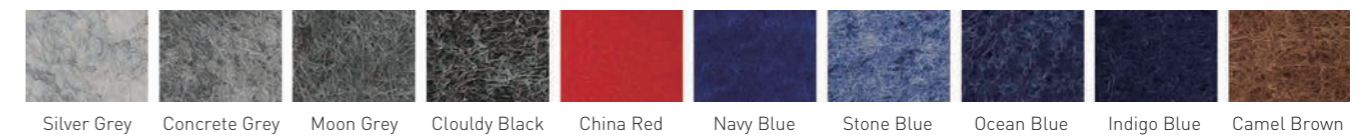

DIMENSIONS

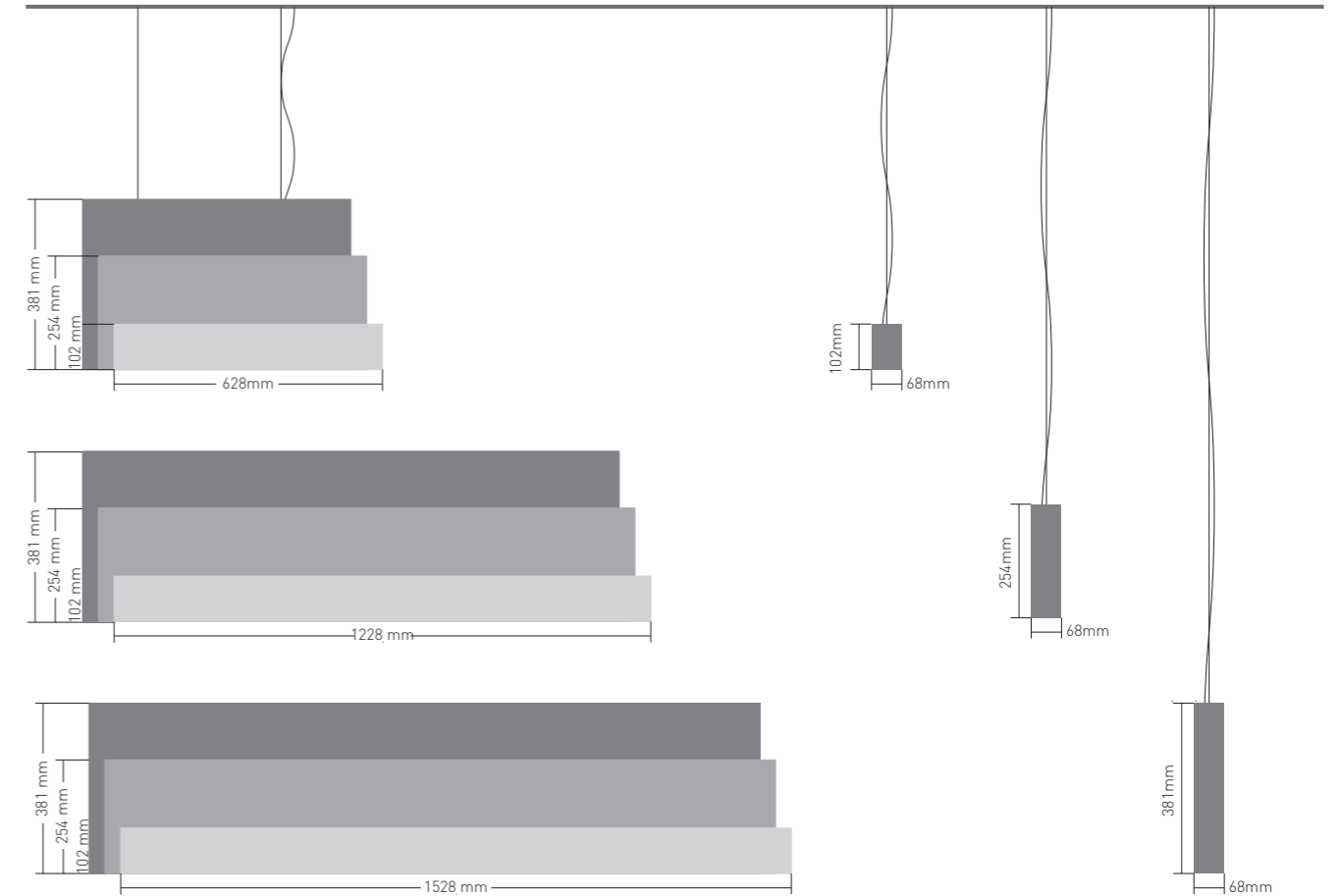

SPECIFICATIONS

	Color Temperature		Lumen / Length	
RA 90	2700K	963lm / 0.6m	1920lm / 1.2m	2333lm / 1.5m
	3000K	1014lm / 0.6m	2021lm / 1.2m	2456lm / 1.5m
	3500K	1067lm / 0.6m	2127lm / 1.2m	2586lm / 1.5m
	4000K	1123lm / 0.6m	2239lm / 1.2m	2722lm / 1.5m
	5000K	1123lm / 0.6m	2239lm / 1.2m	2722lm / 1.5m
	5500K	1123lm / 0.6m	2239lm / 1.2m	2722lm / 1.5m
	6500K	1123lm / 0.6m	2239lm / 1.2m	2722lm / 1.5m
RA 95	2700K	867lm / 0.6m	1728lm / 1.2m	2100lm / 1.5m
	3000K	912lm / 0.6m	1819lm / 1.2m	2211lm / 1.5m
	3500K	960lm / 0.6m	1915lm / 1.2m	2327lm / 1.5m
	4000K	1010lm / 0.6m	2015lm / 1.2m	2449lm / 1.5m
	6500K	1010lm / 0.6m	2015lm / 1.2m	2449lm / 1.5m
SAMSUNG RA 80	3000K	1200lm / 0.6m	2393lm / 1.2m	2909lm / 1.5m
	4000K	1263lm / 0.6m	2519lm / 1.2m	3061lm / 1.5m
	6500K	1263lm / 0.6m	2519lm / 1.2m	3061lm / 1.5m

Note:

- The given data are typical values in PC Diffuser. Due to tolerances of the production process and the electrical components, values for light output and electrical power can vary up to 10%.
- 15% less on luminous flux at Traic driver, DALI and 0/1-10V driver, and -10% Non-Dim driver.
- 10% less on UGR<19 version.
- Above data based on Non-Dimmable for all luminaires.
- More customized LED and CCT available.
- LM-80, IES TM-30-15 testing report available for led.

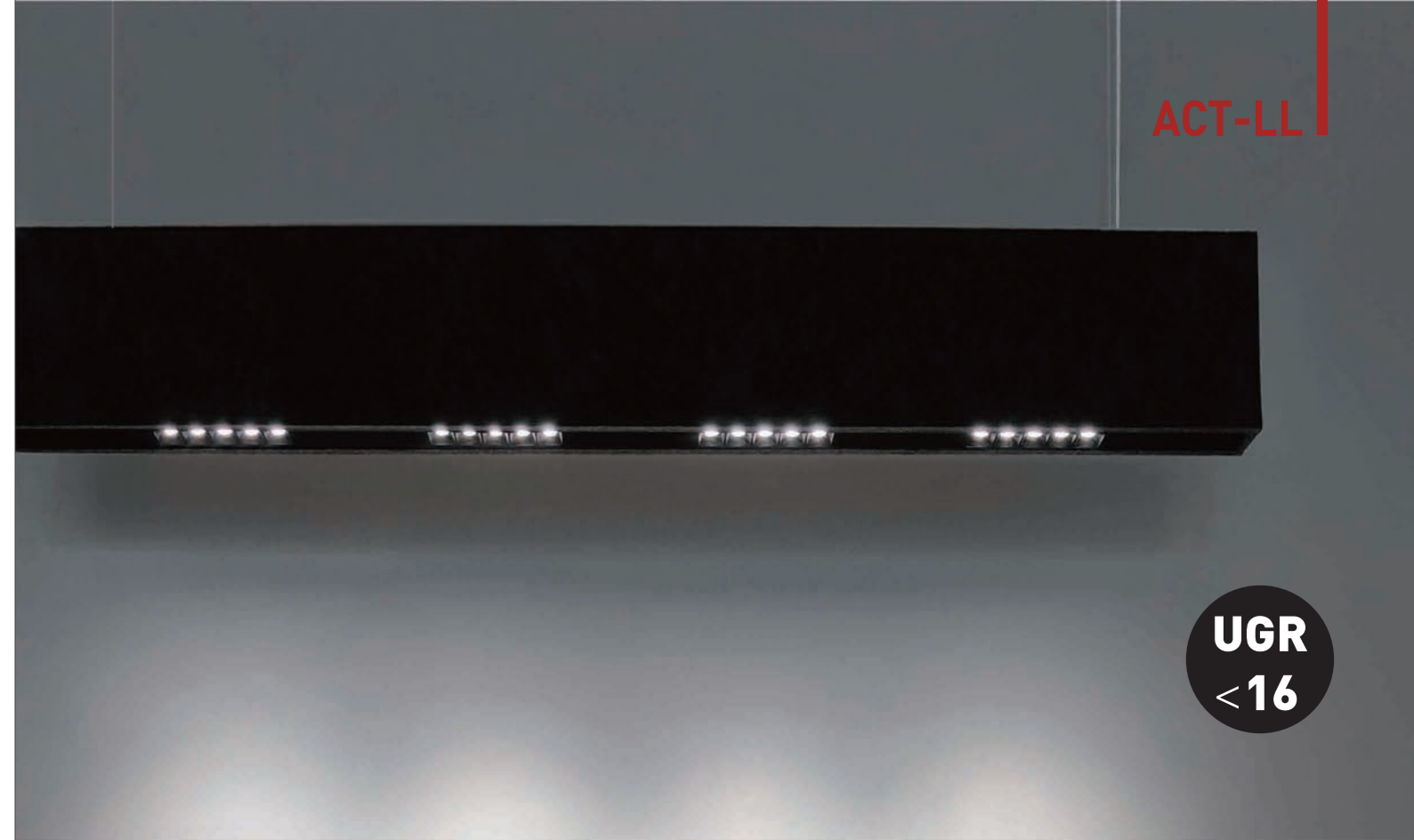

ORDERING INFORMATION

LUMINAIRE	ACOUSTIC CLILOR	LENS	LENGTH	COLOR QUALITY ¹	COLOR TEMP ²	CRI	INSTALL ACCS.	IP GRADE	CONTROL OPTOINS
ACT-LL	S -Silver Grey	15 -15Deg. Reflector Louver	2- 628mm	3 3-Step MacAdam Ellipse	30- 3000K	80 80+ CRI	P Aircraft cable pendant	22 IP22	D1- DALI D2- 0-10V D3- On/off
	C -Concrete Grey								
	M-Moon Grey								
	CB -Cloudy Black	30 -30Deg. Reflector Louver	5- 1528mm		50- 5000K	90 90+CRI			
	CR-China Red								
	N - Navy Blue	45 -45Deg. Reflector Louver			65- 6500K				
	SB - Stone Blue								
	O - Ocean Blue								
	I - Indigo Blue								
	CW - Camel Brown								

1. Vivalyte's standard is 3-Step MacAdam
2. The listed Color Temperature is only available in CRI80+ in Nichia Chips. For more options, pls. check with your executive sales.
3. Nichia's CRI 90+ option's is not the general inventory, the leading time is around 4weeks for it. Please check with your executive sales in details.

COLOR OPTIONS



SPECIFICATIONS

Voltage	220V-240VAC / 100V-240 VAC				
Width / Height	68mm x 102mm	68mm x 254mm	68mm x 381mm		
Length	628mm	1228mm	1528mm		
Power	11 W/pc (2sets module)	23W/pc (4sets module)	27.5W/pc (5sets module)		
Efficacy Up to	90lm/W (RA 80+)	75lm/W (RA 90+)			
Control	Dali , 0-10V, on/off				
NICHIA RA 90	Color Temperature	3000K	4000K	5000K	6500K
	Lumen / Length	758lm / 0.6m	840lm / 0.6m	840lm / 0.6m	840lm / 0.6m
	Lumen / Length	1516lm / 1.2m	1680lm / 1.2m	1680lm / 1.2m	1680lm / 1.2m
	Lumen / Length	1895lm / 1.5m	2100lm / 1.5m	2100lm / 1.5m	2100lm / 1.5m

Note:

- The given data are typical values in 4sets 30Deg. Reflector Louver kit. Due to tolerances of the production process and the electrical components, values for light output and electrical power can vary up to 10%.
- 15% less on luminous flux at Traic driver, DALI and 0/1-10V driver, and -10% Non-Dim driver.
- Above data based on Non-Dimmable for all luminaires.

BEAM ANGLE

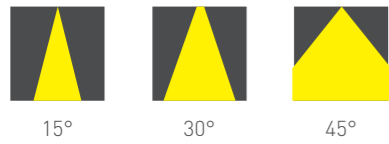

LED CHIPS AND DRIVER OPTIONS



DIMENSIONS

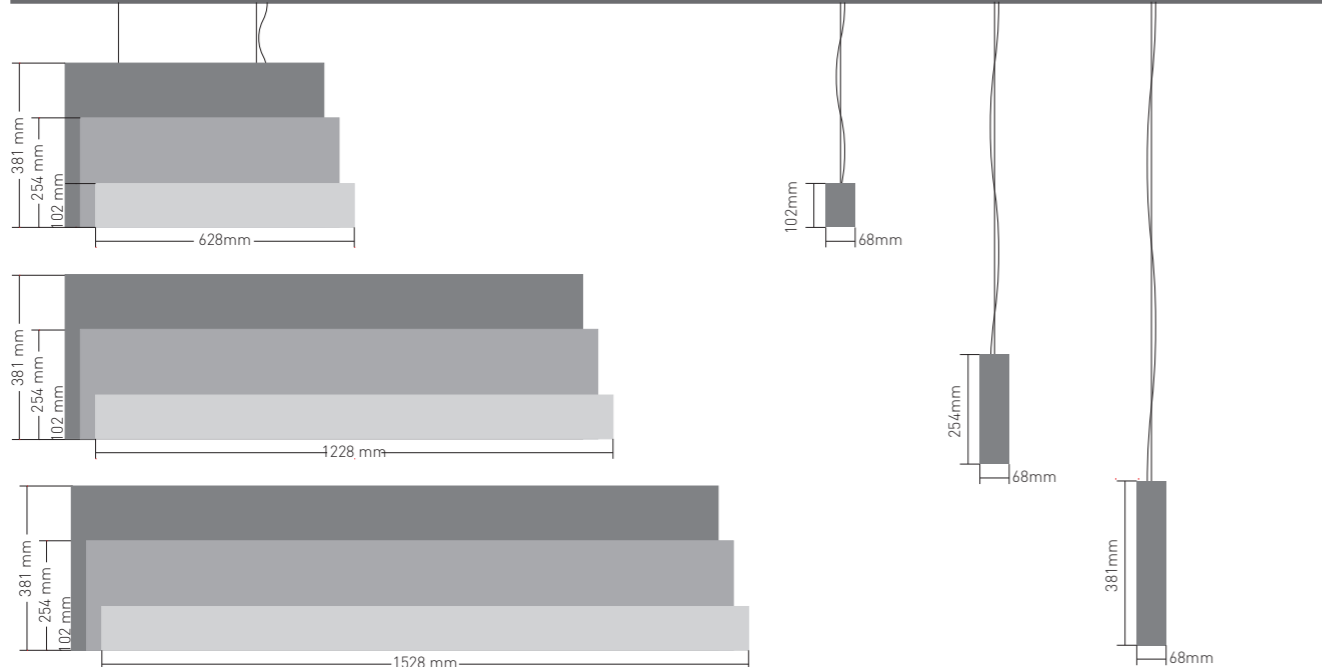

ASYMMETRIC OPTICAL LENS



ORDERING INFORMATION

LUMINAIRE	ACOUSTIC COLOR	LENS	LENGTH	COLOR QUALITY ¹	COLOR TEMP ²	CRI	INSTALL ACCS.	IP GRADE	CONTROL OPTOINS
ACT-LW	S -Silver Grey	60 -60Deg. PMMA Lens	4- 1220mm Fixed length	3 3-Step MacAdam Ellipse	30- 3000K	80 80+CRI	P Aircraft cable pendant	22 IP22	D1- DALI D2- 0-10V D3- On/off
	C -Concrete Grey				40- 4000K				
	M-Moon Grey	90 -90Deg. PMMA Lens	50- 5000K		90 90+ CRI				
	CB -Cloudy Black	65- 6500K							
	CR-China Red	BA -Batwing PMMA Lens							
	N - Navy Blue								
	SB - Stone Blue	AS- Asymmetric PMMA Lens							
	O - Ocean Blue								
	I - Indigo Blue								
	CW - Camel Brown								

1. Vivalyte's standard is 3-Step MacAdam
2. The listed Color Temperature is only available in CRI80+ in Nichia Chips. For more options, pls. check with your executive sales.
3. Nichia's CRI 90+ option's is not the general inventory, the leading time is around 4weeks for it. Please check with your executive sales in details.

SPECIFICATIONS

Voltage	220V-240VAC / 100V-240 VAC		
Width / Height	68mm x 102mm	68mm x 254mm	68mm x 381mm
Length	1220mm		
Power (W/m /ft)	31.1 W/pc		
Efficacy Up to	90lm/w		
Control	Dali , 0-10V, on/off		

LED CHIPS AND DRIVER OPTIONS



SPECIFICATIONS

	3000K	4000K	5000K	6500K
RA 90	1516lm / 1.2m	1680lm / 1.2m	1680lm / 1.2m	1680lm / 1.2m
RA 95	1516lm / 1.2m	1680lm / 1.2m	1680lm / 1.2m	1680lm / 1.2m
SAMSUNG RA80	1516lm / 1.2m	1680lm / 1.2m	1680lm / 1.2m	1680lm / 1.2m

Note:

- The given data are typical values in 4000K CRI80+. Due to tolerances of the production process and the electrical components, values for light output and electrical power can vary up to 10%.
- 15% less on luminous flux at Traic driver, DALI and 0/1-10V driver, and -10% Non-Dim driver.
- Above data based on Non-Dimmable for all luminaires.
- More customized LED and CCT available.

COLOR OPTIONS



DIMENSIONS

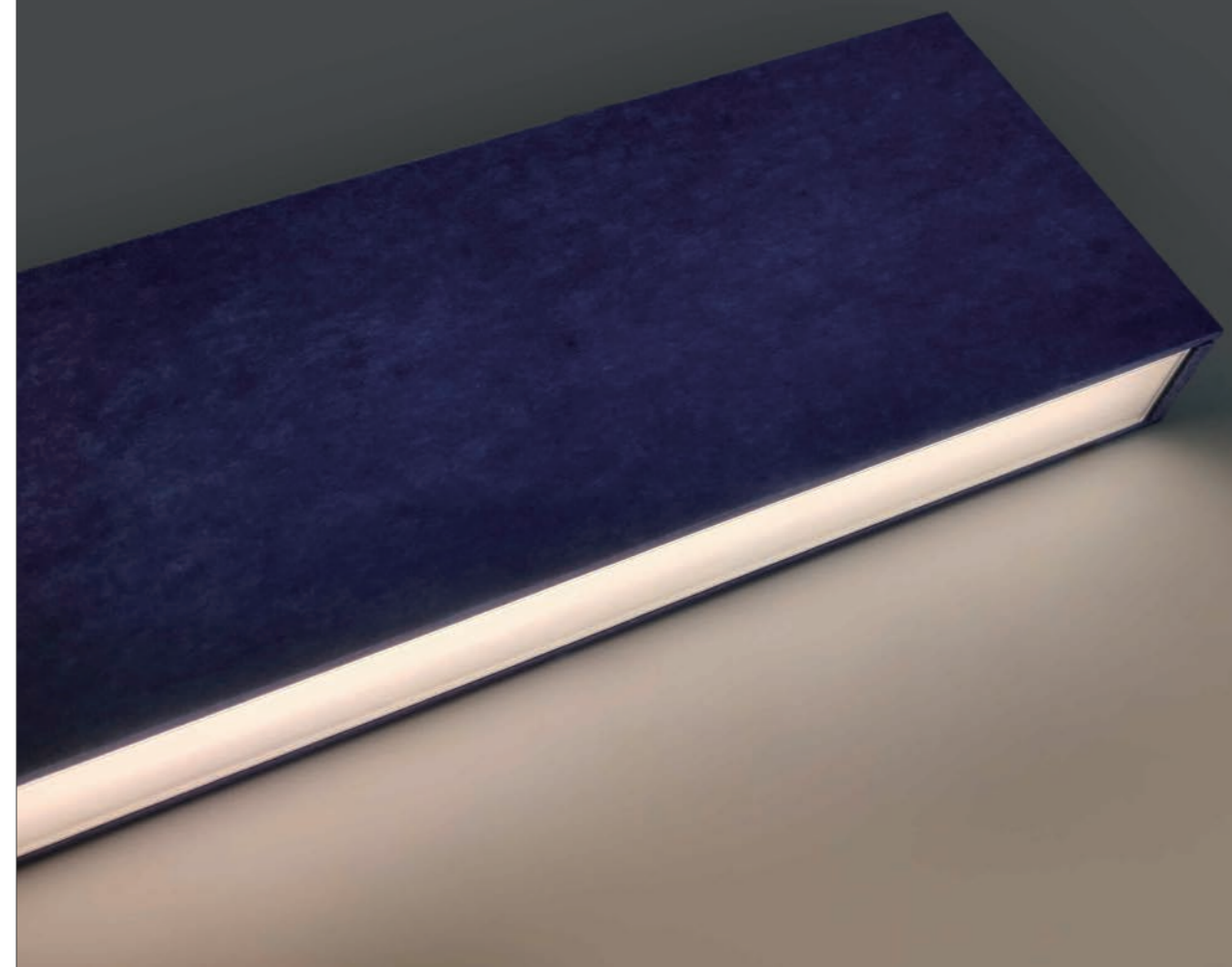
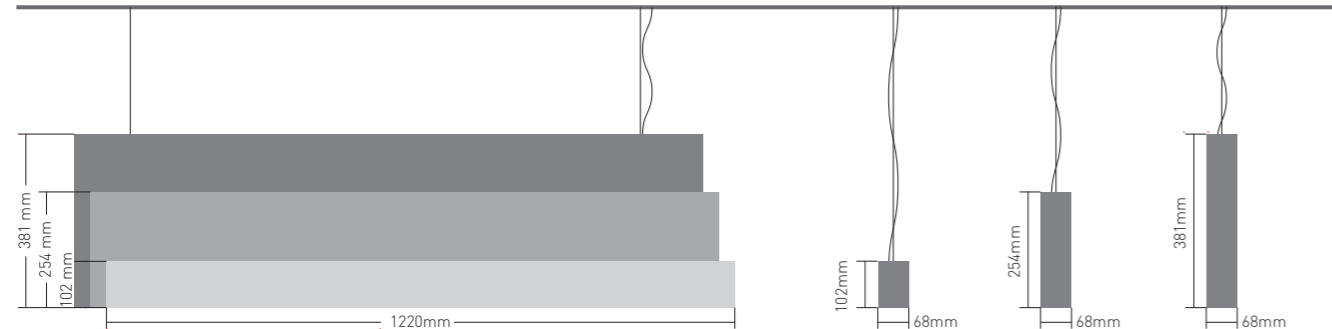

UGR <19

ORDERING INFORMATION

LUMINAIRE	ACOUSTIC COLOR	LENS	LENGTH	COLOR QUALITY ¹	COLOR TEMP ²	CRI	INSTALL ACCS.	IP GRADE	CONTROL OPTOINS
ACT-H	S- Silver Grey	U UGR <19 Kit	2- 628mm	3 3-Step MacAdam Ellipse	27- 2700K	90 90+ CRI	P Aircraft cable pendant	22 IP22	D1- DALI D2- 0-10V D3- On/off
	C- Concrete Grey		4- 1228mm		30- 3000K				
	M- Moon Grey		5- 1528mm		35- 3500K				
	CB- Cloudy Black	D Diffuser	5- 1528mm	5 5-Step MacAdam Ellips	40- 4000K	95 95+ CRI			
	CR- China Red				50- 5000K				
	N- Navy Blue				60- 6000K				
	SB- Stone Blue				65- 6500K				
	O- Ocean Blue								
	I- Indigo Blue								
	CW- Camel Brown								

1. Vivalyte's standard is 3-Step MacAdam
 2. The listed Color Temperature is only available in CRI80+ in Epistar Chips, for 95+, 90+ in Epistar and Sumsung chips, pls. check the list on following page. For more options, pls. check with your executive sales.

SPECIFICATIONS

LED CHIPS AND DRIVER OPTIONS

Voltage	220V-240 VAC / 110-240VAC		
Width / Height	93mm x 102mm	93mm x 254mm	93mm x 381mm
Length	628mm	1228mm	1528mm
Power (W/m /ft)	28 W/pc	56 W/pc	64 W/pc
Efficacy Up to	85lm/w	90lm/w	90lm/w
Control	Dali , 0-10V, on/off		



COLOR OPTIONS

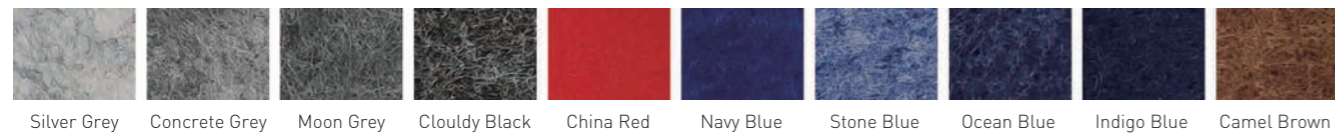

DIMENSIONS

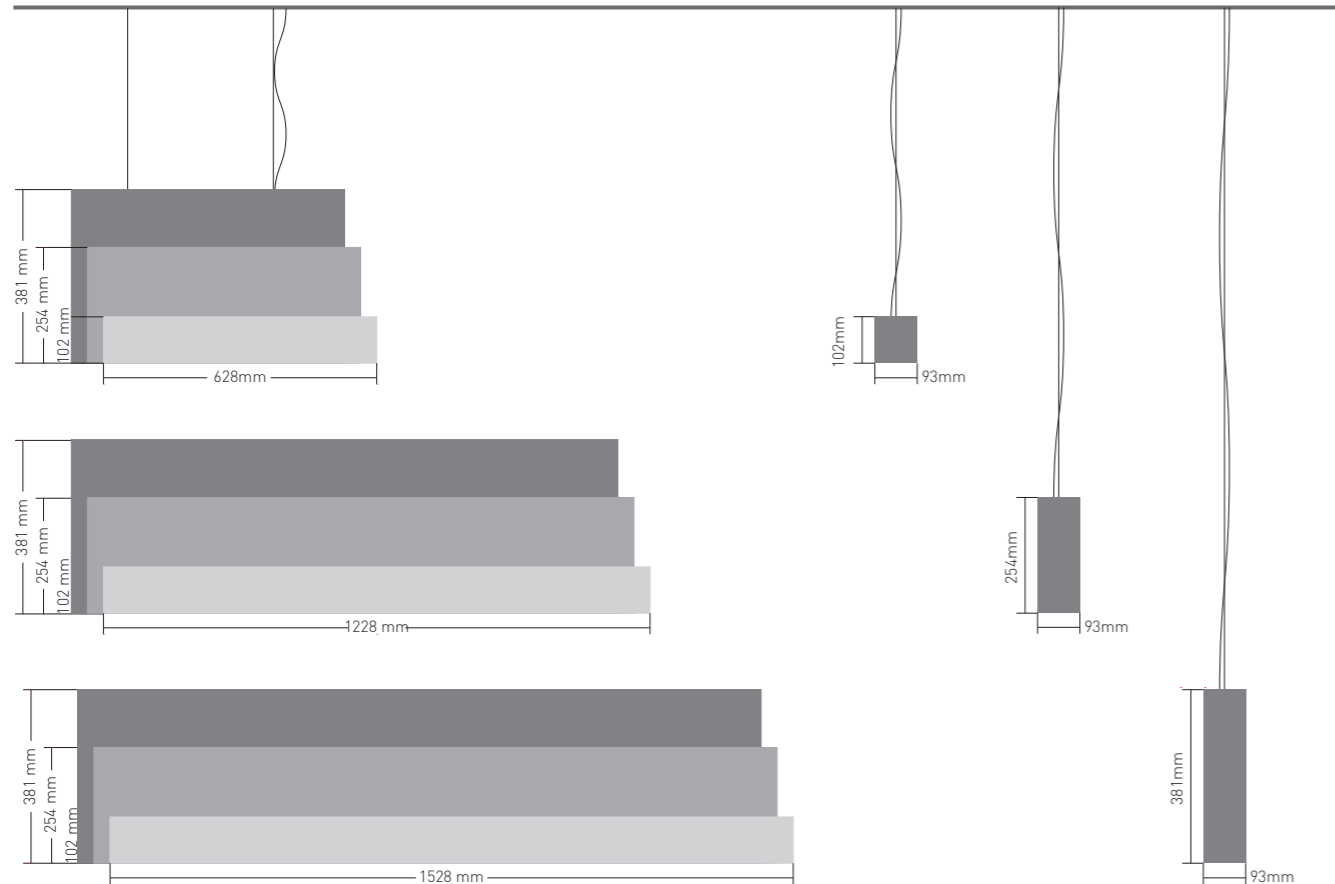

SPECIFICATIONS

	Color Temperature		Lumen / Length	
RA 90	2700K	1728lm / 0.6m	3457lm / 1.2m	3951lm / 1.5m
	3000K	1819lm / 0.6m	3639lm / 1.2m	4159lm / 1.5m
	3500K	1915lm / 0.6m	3830lm / 1.2m	4378lm / 1.5m
	4000K	2016lm / 0.6m	4032lm / 1.2m	4608lm / 1.5m
	5000K	2016lm / 0.6m	4032lm / 1.2m	4608lm / 1.5m
	6000K	2016lm / 0.6m	4032lm / 1.2m	4608lm / 1.5m
RA 95	2700K	1555lm / 0.6m	3110lm / 1.2m	3556lm / 1.5m
	3000K	1637lm / 0.6m	3274lm / 1.2m	3743lm / 1.5m
	3500K	1723lm / 0.6m	3447lm / 1.2m	3940lm / 1.5m
	4000K	1814lm / 0.6m	3628lm / 1.2m	4147lm / 1.5m
	6500K	1814lm / 0.6m	3628lm / 1.2m	4147lm / 1.5m
SAMSUNG RA 80	3000K	2047lm / 0.6m	4094lm / 1.2m	4679lm / 1.5m
	4000K	2268lm / 0.6m	4536lm / 1.2m	5184lm / 1.5m
	6500K	2268lm / 0.6m	4536lm / 1.2m	5184lm / 1.5m

- Note:**
- The given data are typical values in PC Diffuser. Due to tolerances of the production process and the electrical components, values for light output and electrical power can vary up to 10%.
 - 15% less on luminous flux at Traic driver, DALI and 0/1-10V driver, and -10% Non-Dim driver.
 - 10% less on UGR<19 version.
 - Above data based on Non-Dimmable for all luminaires.
 - More customized LED and CCT available.
 - LM-80, IES TM-30-15 testing report available for led.



AVAILABLE SIZE

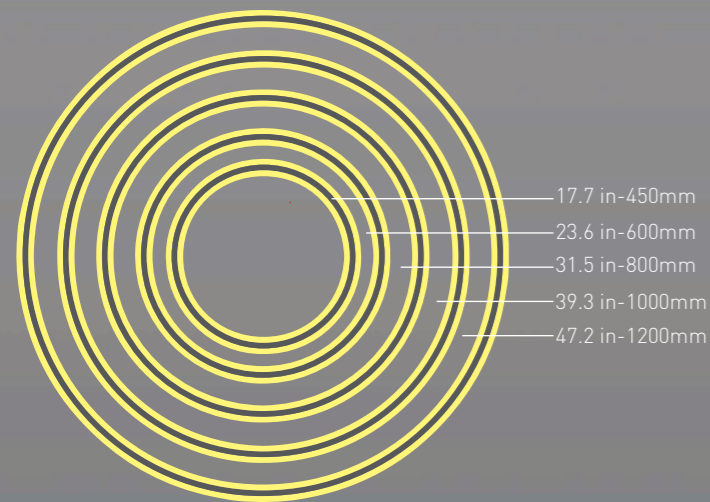

ORDERING INFORMATION

LUMINAIRE	ACOUSTIC COLOR	LENS	DIAMETER	COLOR QUALITY ¹	COLOR TEMP ²	CRI	INSTALL ACCS.	IP GRADE	CONTROL OPTOINS
ACT-R30	S- Silver Grey C- Concrete Grey M- Moon Grey CB- Cloudy Black CR- China Red N- Navy Blue SB- Stone Blue O- Ocean Blue I- Indigo Blue CW- Camel Brown	S- Silicone	4- Φ450mm 6- Φ600mm 8- Φ800mm 10- Φ1000mm	3 3-Step MacAdam Ellipse	30- 3000K 40- 4000K 60- 6000K TW- Tunable White	80 80+ CRI 90 90+ CRI	P Aircraft cable pendant	22 IP22	D1- DALI D2- 0-10V D3- On/off

SPECIFICATIONS

Voltage	90-265 VAC			
Diameter	Φ450mm	Φ600mm	Φ800mm	Φ1000mm
Power	25W	35W	40W	50W
Efficacy Up to	1530lm	2330lm	2500lm	3423lm
Control	Dali , 0-10V, on/off			

Note: The given data are typical values. Due to tolerances of the production process and the electrical components, values for light output and electrical power can vary up to 10%.
-15% luminous flux at Traic driver, DALI and 0/1-10V driver, and -10% Non-Dim driver.

OPTIONAL COLOR

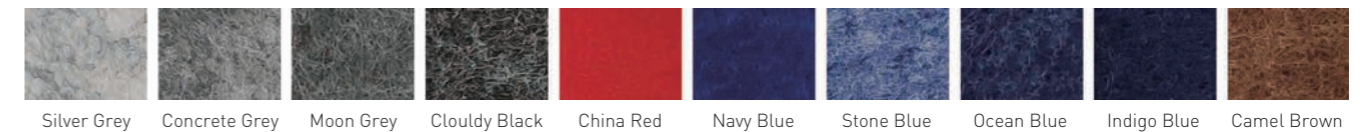



AVAILABLE SIZE

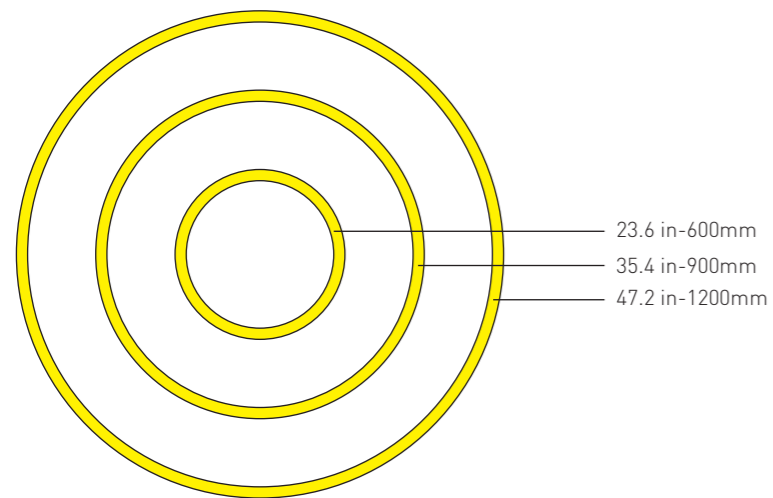

ORDERING INFORMATION

LUMINAIRE	FINISH	ACOUSTIC COLOR	LENS	DIAMETER	COLOR QUALITY ¹	COLOR TEMP ²	CRI	INSTALL ACCS.	CONTROL OPTOINS			
ACT-R35	W White	S- Silver Grey	D Diffuser	6 Φ600mm	3 3-Step MacAdam Ellipse	27- 2700K	80 80+ CRI	P Aircraft cable pendant	D1- DALI D2- 0-10V D3- On/off			
		C- Concrete Grey										
	B Black	M- Moon Grey		9 Φ900mm						5 5-Step MacAdam Ellips	30- 3000K	90 90+ CRI
		CB- Cloudy Black										
	S Silver	CR- China Red		12 Φ1200mm						50- 5000K	60- 6000K	95 95+ CRI
		N- Navy Blue										
		SB- Stone Blue										
		O- Ocean Blue										
		I- Indigo Blue										
		CW- Camel Brown										

1. Vivalyte's standard is 3-Step MacAdam

2. The listed Color Temperature is only available in CRI80+ in Epistar Chips, for 95+, 90+ in Epistar and Sumsung chips, pls. check the list on following page. For more options, pls. check with your executive sales.

SPECIFICATION

Voltage	220V-240VAC / 100V-240 VAC		
Width / Diameter	35 × 30mm		
Diameter	Φ600mm	Φ900mm	Φ1200mm
Power	25W/pc	34 W/pc	70 W/pc
Efficacy Up to	80lm/w	80lm/w	80lm/w
Control	Dali , 0-10V, on/off		

LED CHIPS AND DRIVER OPTIONS



OPTIONAL COLOR

